

Data Sheet



Article number: 604133030040

Description: Taper bored timing belt pulley
HTD 30 14M 40 TL 2012

Measures

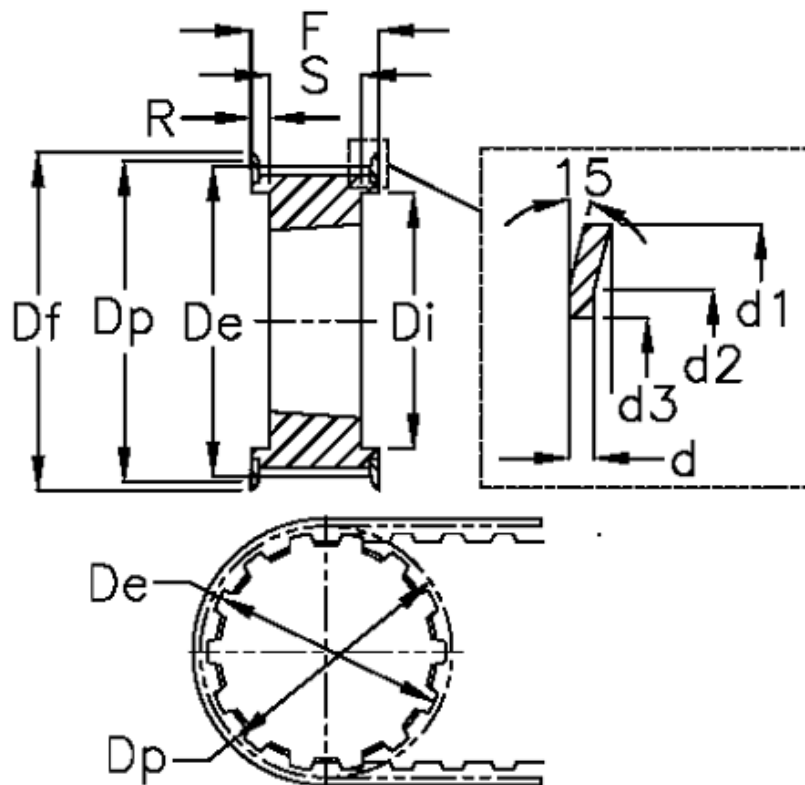

d = 2.5	F = 54	Weight = 2.65
d1 = 138	Flange type = F43	Width = 40
d2 = 132	For bushing = 2012	
d3 = 121	Max bore = 50	
De = 130.99	r = 11	
Df = 138	S = 32	
Di = 98	Tooth number = 30	
Dp = 133.69	Type = 14M	